

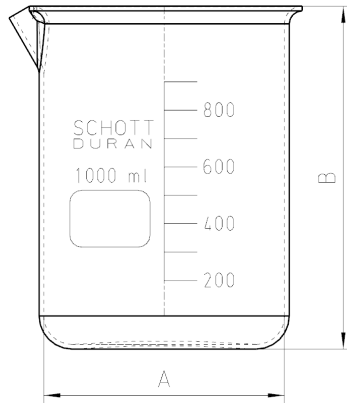

Part **Beaker**
 Part Number **03061-2**
 Serial Number **93401 - 93450**



Test Certificate

			USP / Ph.Eur. Tolerances	
Dimensions	Beaker	Inside Ø a	104.5 to 107.5 mm	97 – 115 mm
		Height b	145 mm	138 – 160 mm
		With straight bottom		
Material	Borosilicate glass			

The accuracy of the above mentioned part dimensions have been examined. All relevant measurements are within tolerance and the factory acceptance test has passed. The dimensions are in conformance with USP and Ph. Eur. Pharmacopoeia requirements (at date of approval, see below).

Aesch, 2022-08-26

Bruno Balli
 SOTAX Quality Management
 SOTAX AG | Nordring 1 | 4147 Aesch | Switzerland