

Certificate of Compliance

Part Description: **Basket Holder with stirring shaft**
 Part Number: 7558-07
 Serial Number: H160501 - H161025

For SOTAX SDT - Dissolution Testing Systems

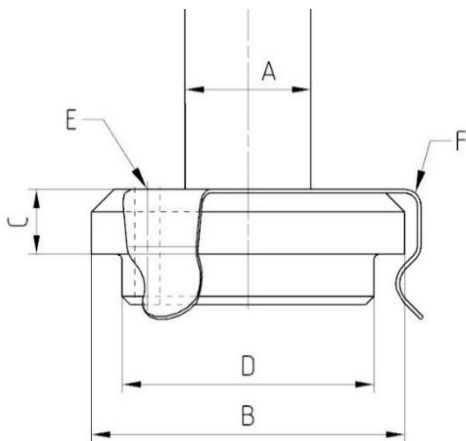

Parameter	USP <711> Dissolution	Actual
A Shaft Ø:	9.40 – 10.10	9.98 – 10.00
B Cap Ø:	22.00 – 28.00	24.88 – 24.92
C Cap size:	4.60 – 5.60	4.75 – 4.95
D Clear opening:	19.20 – 21.20	20.00 – 20.10
E Vent hole Ø:	1.50 – 2.50	1.90 – 2.10
F Retention spring:	3 tangs on 120 ° centers	
Material:	Stainless Steel	

all readings are in mm and °

The accuracy of the above mentioned part dimensions have been examined in accordance to ISO-Norm ISO 2859. All used instruments are controlled by the SOTAX measuring equipment monitoring according ISO 9001.

All relevant measurements are within tolerance and the factory acceptance test has passed. The dimensions are in conformance with USP Pharmacopeia requirements (at time of delivery).

Inspected

Name: Moreshwar Pulekar

Date: 25-08-2017

Signature:

18.09.10 - 25.08.2017